

OBLIQUE 2x4 LED

HOUSING

TO BE FORMED FROM 20GA CRS
 FINISH: ECO WHITE (STANDARD)
 ALL STEEL PARTS ARE PHOSPHATE
 TREATED FOR CORROSION RESISTANCE
 BEFORE PAINT PROCEDURE, THEN
 BAKED WITH SUPERIOR ADHESION
 FOR DURABILITY

LED MODULES

HIGHER EFFICACY UP TO 170 LPW
 WITH SERVICE LIFE GREATER THAN
 60000(L70) HIGH COLOR RENDER AND
 EXCELLENT COLOR CONSISTENCY
 COLOR OPTIONS AVAILABLE FROM
 27K TO 40K .
 90 CRI LEDS AVAILABLE AS OPTIONAL

DRIVERS

CONSTANT CURRENT, CLASS 2
 UNIVERSAL INPUT : 120-277VAC
 SOUND RATED A, 54V OUTPUT 0-10V
 DIMMING STANDARD .
 DALI, ECOSYSTEM AND DMX DRIVERS
 ALSO AVAILABLE

REFLECTOR

TO BE FORMED FROM 20GA CRS
 FINISH: BAKED WHITE ENAMEL WITH
 90% REFLECTIVITY

MOUNTING

FLANGE, SLOT GRID
 FLANGELESS, 1/16 GRID(T)
 9/16 GRID(T1)

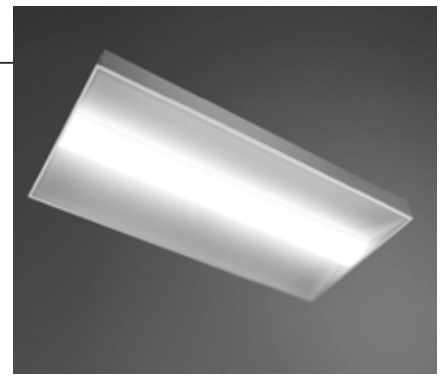

PRODUCT DESCRIPTION

THE OBLIQUE 2'X4' LED DELIVERS AESTHETICS, AND
 DIGITAL LED LIGHTING. THE EXCELLENT COMBINES DIGITAL
 LED LIGHTING WITH HIGH PERFORMANCE OF THE OPTICAL
 SYSTEM IS IDEAL FOR CLASS ROOMS, LARGE AND SMALL
 OFFICES AND HEALTH CARE FACILITIES . THE FROSTED
 LINEAR PRISMS ARE INTEGRAL TO THE EXTRUDED ACRYLIC
 DIFFUSER . IN COMBINATION WITH THE OPTICAL SYSTEM
 LIGHT IS DISTRIBUTED EVENLY INTO THE SPACE.

TYPE: _____

PROJECT: _____

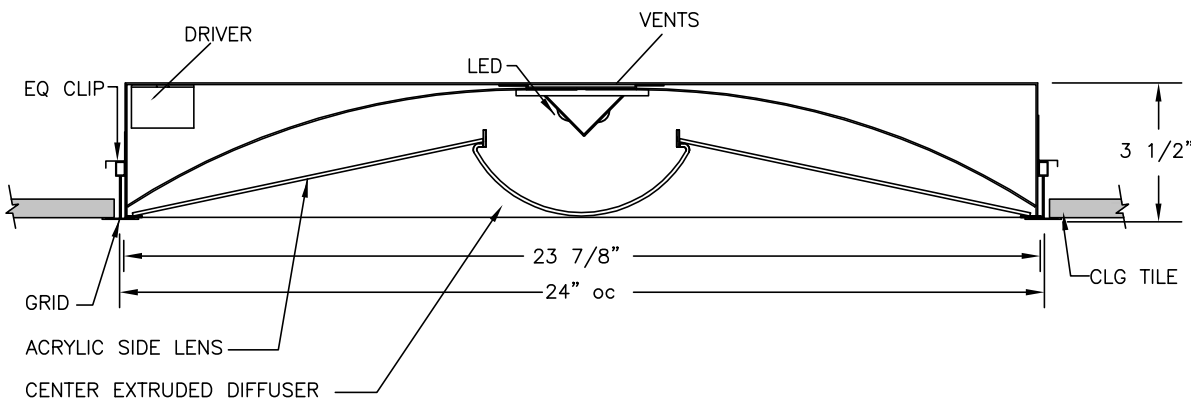

EVEN AND VISUALLY
 COMFORTABLE LED
 LIGHT DISTRIBUTION
 ACROSS PROFILE OF
 THE PRODUCT

50% ENERGY
 SAVINGS COMPARED
 TO LINEAR
 FLUORESCENT

SUSTAINABLE
 MATERIALS

ARRAY OF LUMEN
 OPTIONS ALL
 LM79/LM80 UL
 APPROVED

5 YEAR WARRANTY
 LED AND DRIVER

CEILING OPTIONS

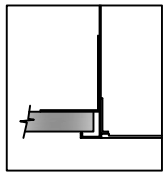

FLANGE(F)

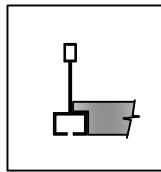

SLOT GRID(SG)

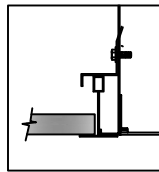

GRID (T)

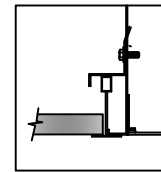

9/16"GRID (T1)

ORDERING KEY

SERIES	LUMENS (WATTS)	COLOR TEMP	CEILING TYPE	VOLTAGE	OPTIONS
OBLIQUE 24LED	<input type="checkbox"/> LO 4150(41W) <input type="checkbox"/> MO 5513(52W) <input type="checkbox"/> HO 7518(68W) Please contact National for other options.	<input type="checkbox"/> 2700K** <input type="checkbox"/> 3000K <input type="checkbox"/> 3500K <input type="checkbox"/> 4000K <input type="checkbox"/> 5000K Contact National For 2700K Option	<input type="checkbox"/> T <input type="checkbox"/> F <input type="checkbox"/> SG <input type="checkbox"/> T1	<input type="checkbox"/> 120 V <input type="checkbox"/> 277 V <input type="checkbox"/> UNIVERSAL	<input type="checkbox"/> EM <input type="checkbox"/> DIM 0-10 <input type="checkbox"/> DALI <input type="checkbox"/> Hilume 1% 2 Wire-LTEA2W <input type="checkbox"/> Hilume 1% Eco-LDE1 <input type="checkbox"/> Hilume 5% LDE5

LUMENS WILL VARY
 DEPENDING ON DIFFUSER
 AND LED COLOR TEMP.

NATIONAL 3E/LED SERIES USES ENGINE/STICK ORIGINAL EQUIPMENT (BY OSRAM, PHILIPS,
 SAMSUNG, ET AL) WHICH ARE RATED FOR APPROXIMATELY 150 LM/W. ARCHITECTURAL
 LENSES PROVIDED WITH THE LUMINAIRES BY DESIGN EVEN THE BRIGHTNESS AND VISUAL
 COMFORT AND MIGHT FRACTIONALLY LOWER LM/W.

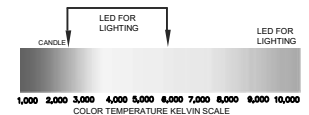

- EM
- DIM 0-10
- DALI
- Hilume 1% 2 Wire-LTEA2W
- Hilume 1% Eco-LDE1
- Hilume 5% LDE5

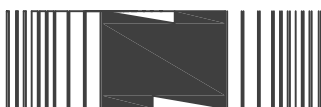

522 CORTLANDT ST.
 BELLEVILLE, NJ 07109

NJ 973-751-1600
 NY 212-751-1600
 FAX 973-751-4931
 WWW.NATLTG.COM



OBLIQUE 2X4 LED-LO

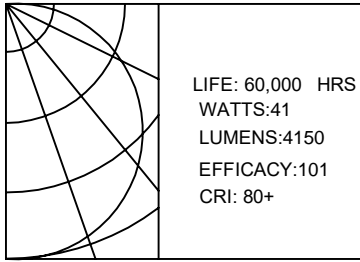

OBLIQUE 2X4 LED-MO

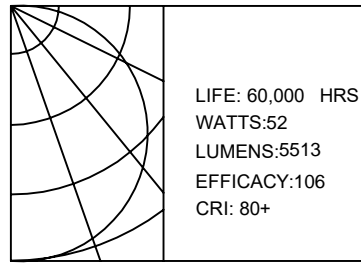

OBLIQUE 2X4 LED-HO

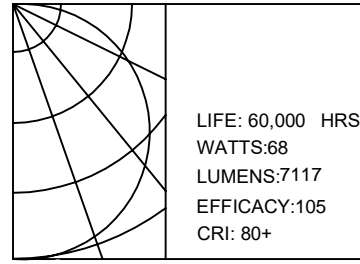

MOUNTING INSTRUCTIONS

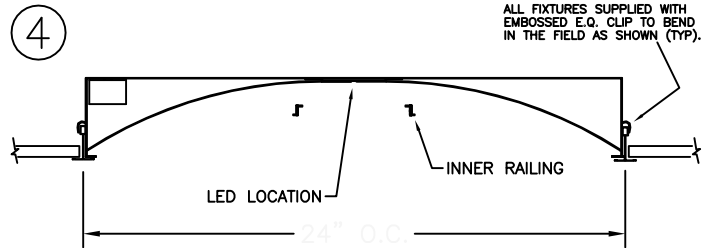
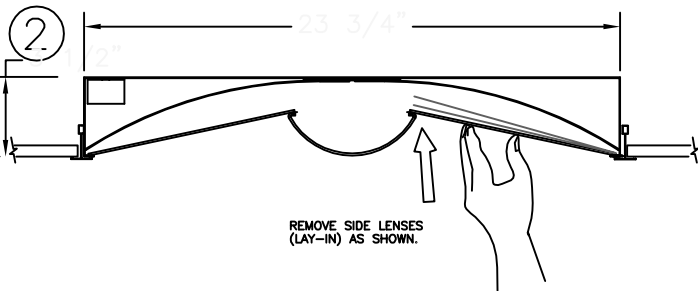
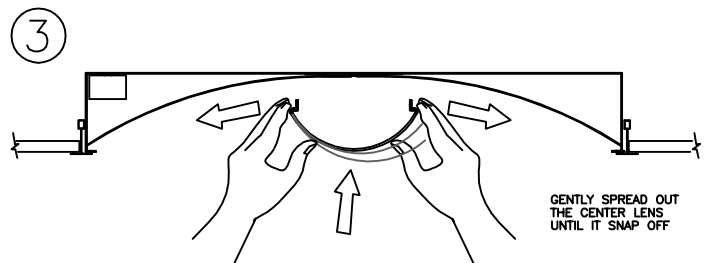
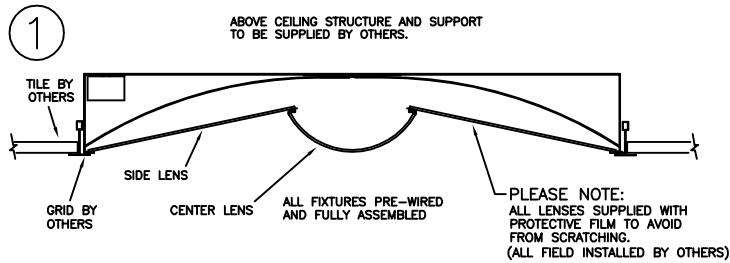

LIGHTING CONTROL SOLUTIONS

- 1. DIMMING (0-10V, DALI Or Lutron)**
 - 0-10V Dimming Driver used as standard.
 - Continuous Dimming up to 10%.
 - Dimming wires not provided unless specified
 - Contact National for Dali or Lutron Control system
- 2. Occ/DAYLIGHT/Vacancy/Bi-Level**
 - Sensor-ready and compatible drivers provided.
 - Sensors can be field installed or could be installed in the fixtures
 - Bi-level dimming and Motion sensors also available
- 3. Compatibility:**

National fixtures are compatible with Lutron, Philips Actilume, Magnum, Wattstopper, Hubbell , Leviton , Hytronik , Daintree & Enlighted Control System

GREENFIELD OPTIONS

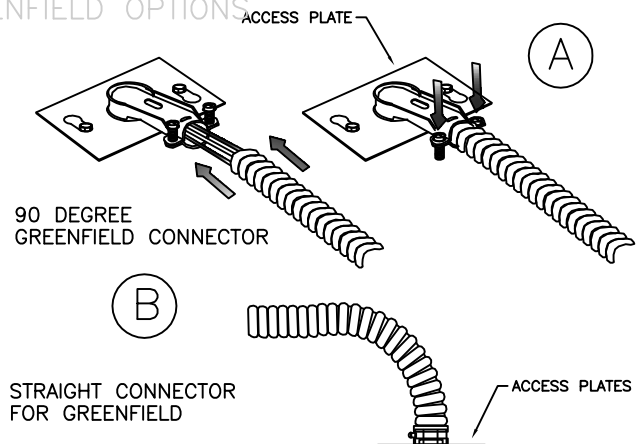

NATIONAL LIGHTING COMPANY, INC.
522 CORTLANDT ST.
BELLEVILLE, NJ 07109

NJ 973-751-1600
NY 212-751-1600
FAX 973-751-4931
WWW.NATLTG.COM

JOB NAME:
CATALOG:
TYPE: