

S18 D/ID LED

HOUSING

TO BE FORMED FROM 20GA CRS.
FINISH: BAKED WHITE ENAMEL (STANDARD)
ALL FIXTURES ARE PRE-WIRED.
ALL STEEL PARTS ARE PHOSPHATE
TREATED FOR CORROSION RESISTANCE
BEFORE PAINT PROCEDURE, THEN
BAKED WITH SUPERIOR ADHESION FOR
DURABILITY.

LED MODULES

MID POWER FR4 LED
(INSTALLED 3000K-4000K)
2 LIGHT CROSS SECTION ARRAY

DRIVERS

LED ELECTRONIC DRIVER 30W-75W
VOLTAGE: 120V-277V (UNIVERSAL)
CLASS 2
UL AND ROHS COMPLIANCE

REFLECTOR

TO BE FORMED FROM 20GA. CR.S.
FINISH: BAKED WHITE ENAMEL
WITH 89% REFLECTIVITY

MOUNTING

CABLE MOUNT / PENDANT

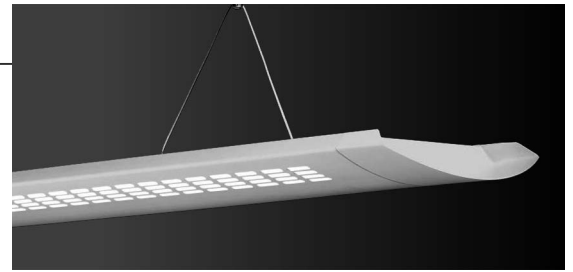

PRODUCT DESCRIPTION

THE S18 LED REFLECTING SYSTEM IS DESIGNED FOR WIDE SPACING OF FIXTURES WITH LOW CEILING BRIGHTNESS. THIS FIXTURE IS ONLY 1.50" X 8.50" IN CROSS SECTION. THE HOUSING IS PERFORATED WITH 1.20" SLOTS TO ENHANCE ANY SMALL OR LARGE SPACE. **THE MODERN LOW PROFILE STEALTH DESIGN HAS TAKEN FORM AND FUNCTION LED LIGHTING TO A NEW LEVEL. DESIRED LIGHT LEVELS CAN BE OBTAINED WITH PENULTIMATE VISUAL COMFORT. THE SCULPTURED FIXTURE IS IDEAL FOR OPEN OFFICES, PRIVATE OFFICES, CONFERENCE ROOMS AND TODAY'S LARGE COMMUNAL BALLPEN SPACES.** 50,000 HOURS OF LAMP LIFE AND EXCELLENT COLOR ARE THE PRODUCTS OF THE INNOVATIVE LED SYSTEM.

TYPE: _____

PROJECT: _____

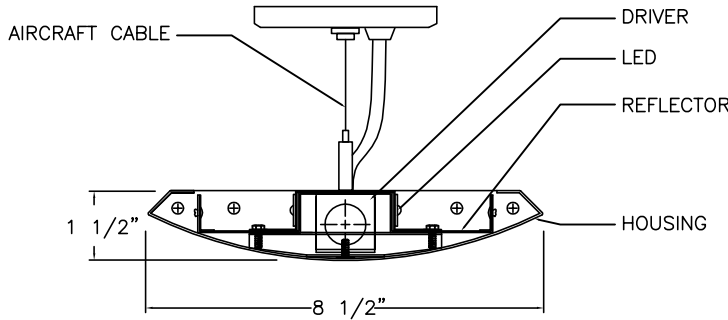

EVEN AND VISUALLY
COMFORTABLE LED
LIGHT DISTRIBUTION
ACROSS PROFILE OF
THE PRODUCT

50% ENERGY
SAVINGS COMPARED
TO LINEAR
FLUORESCENT

SUSTAINABLE
MATERIALS

ARRAY OF LUMEN
OPTIONS ALL
LM79/LM80 UL
APPROVED

5 YEAR WARRANTY
LED AND DRIVER

ORDERING KEY

SERIES	Lumens/ft(Watts/ft)	LENGTH	COLOR TEMP	MOUNTING	VOLTAGE	OPTIONS
S18 LED	<input type="checkbox"/> 800(8.5)	<input type="checkbox"/> 4'	<input type="checkbox"/> 2700K	<input type="checkbox"/> AC - CABLE	<input type="checkbox"/> 120 V	<input type="checkbox"/> EM
	<input type="checkbox"/> 1065 (10.9)	<input type="checkbox"/> 8'	<input type="checkbox"/> 3000K	<input type="checkbox"/> P - STEM	<input type="checkbox"/> 277 V	<input type="checkbox"/> DIM 0-10
	<input type="checkbox"/> 1268 (14.5)	<input type="checkbox"/> ROWS	<input type="checkbox"/> 3500K	<input type="checkbox"/> 24"	<input type="checkbox"/> UNIVERSAL	<input type="checkbox"/> DALI
			<input type="checkbox"/> 4000K	<input type="checkbox"/> 48"		<input type="checkbox"/> Hilume 1%LTEA2W
			<input type="checkbox"/> 5000K	<input type="checkbox"/> OTHER _____		<input type="checkbox"/> Hilume 1% Eco-LDE1
						<input type="checkbox"/> Hilume 5% LDE5

LUMENS WILL VARY
DEPENDING ON DIFFUSER
AND LED COLOR TEMP.

NATIONAL 3ELED SERIES USES ENGINE/STICK ORIGINAL EQUIPMENT (BY OSRAM, PHILIPS, SAMSUNG, ET AL) WHICH ARE RATED FOR APPROXIMATELY 100 LM/W. ARCHITECTURAL LENSES PROVIDED WITH THE LUMINAIRES BY DESIGN EVEN THE BRIGHTNESS AND VISUAL COMFORT AND MIGHT FRACTIONALLY LOWER LM/W.

Hilume 1% 2 Wire-LTEA2W
Hilume 1% Eco-LDE1
Hilume 5% LDE5

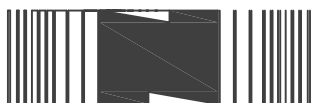
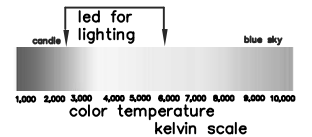

522 CORTLANDT ST.
BELLEVILLE, NJ 07109

NJ 973-751-1600
NY 212-751-1600
FAX 973-751-4931
WWW.NATLTG.COM

Modules and drivers are UL recognized components and RoHS compliant. LED modules also comply with IENSA LM-79 and LM-80 standards.



PHOTOMETRICS

S18 DID LED-LO

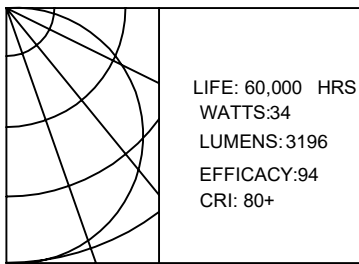

S18 DID LED-MO

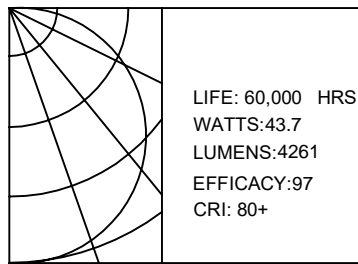

S18 DID LED-HO

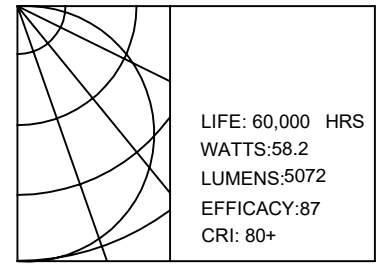

ALL VALUES ARE BASED ON 4' SECTION

JOINING AND INSTALLATION INSTRUCTIONS

MIDDLE FIXTURE

END PLATE W/ HOLES

FIG: A

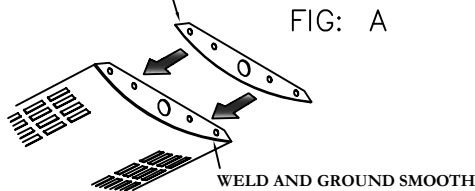

SCOOP END PLATES

END PLATE W/ STUDS

FIG: B

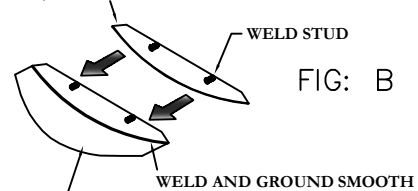

ALL RADIUS MUST MATCH

MUST MATCH

INSIDE MUST BE CLEAN, NO WELD MARKINGS.

SCOOP END PLATE

MUST MATCH

FIG: C

FIXTURE JOINING MUST MATCH FROM SCOOP ENDS, STUDS, TOP TO BOTTOM RADIUS & MTG. HOLES.

ALL RADIUS MUST MATCH

MUST MATCH

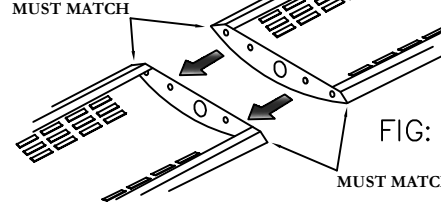

FIG: D

MUST MATCH

FIXTURE JOINING MUST MATCH FROM TOP TO BOTTOM RADIUS & MTG. HOLES.

LIGHTING CONTROL SOLUTIONS

1. DIMMING (0-10V, DALI Or Lutron)

- 0-10V Dimming Driver used as standard.
- Continuous Dimming up to 10%.
- Dimming wires not provided unless specified
- Contact National for Dali or Lutron Control system

2. Occ/DAYLIGHT/Vacancy/Bi-Level

- Sensor-ready and compatible drivers provided.
- Sensors can be field installed or could be installed in the fixtures
- Bi-level dimming and Motion sensors also available

3. Compatibility:

National fixtures are compatible with Lutron, Philips Easy Sense, Magnum, Wattstopper, Hubbell , Leviton , Hytronik , Daintree & Enlighted Control System

END PLATE

END PLATE W/ STUDS

WELD STUI

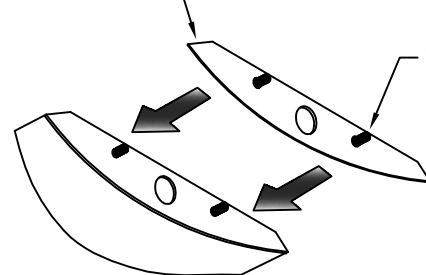

NATIONAL LIGHTING COMPANY, INC.
522 CORTLANDT ST.
BELLEVILLE, NJ 07109

NJ 973-751-1600
NY 212-751-1600
FAX 973-751-4931
WWW.NATLTG.COM

JOB NAME:
CATALOG:
TYPE: